

RYOBI®

MODEL TB720r
BLOWER

OPERATOR'S MANUAL

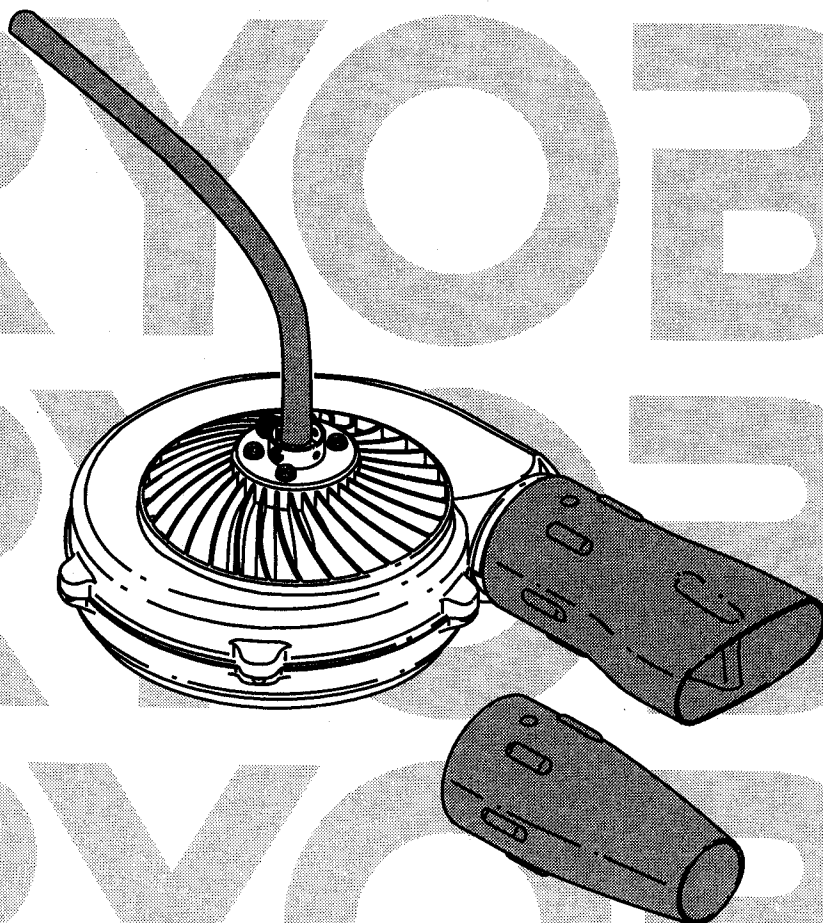

FOR QUESTIONS, CALL 1-800-345-8746 IN U.S., OR 1-800-265-6778 in CANADA

FOR HOUSEHOLD USE ONLY

IMPORTANT MANUAL

DO NOT THROW AWAY

INTRODUCTION

THANK YOU

Thank you for purchasing this quality product. This modern outdoor power tool has been fully assembled and designed to provide you with many hours of useful service. You will find it to be a great labor-saving device.

This operator's manual provides you with easy-to-understand operating instructions. Read the entire manual and follow all of the instructions to keep your new outdoor power tool in top operating condition.

The other manual that came with your power tool, the parts manual, contains all of the information that you need to order parts.

PRODUCT REFERENCES, ILLUSTRATIONS AND SPECIFICATIONS

All information, illustrations and specifications in this manual are based on the latest product information available at the time of printing. We reserve the right to make changes at any time without notice.

TABLE OF CONTENTS

- I. Rules for Safe Operation 2-4
 - A. Safety and International Symbols 4
- II. Operating Instructions 5
 - A. Interchanging Nozzles 6-7
 - B. Using the Flare Nozzle 7
 - C. Using the Concentrator Nozzle 7
- IV. Blower Parts - Model TB720r 8
- V. Warranty 9

Make sure this manual is carefully read and understood before starting or operating this equipment.

Also refer to the operator's manual of the powerhead for additional safety warnings.

NOTE: Proof of purchase will be required for warranty service.

RULES FOR SAFE OPERATION

THE PURPOSE OF SAFETY SYMBOLS IS TO ATTRACT YOUR ATTENTION TO POSSIBLE DANGERS. THE SAFETY SYMBOLS, AND THE EXPLANATIONS WITH THEM, DESERVE YOUR CAREFUL ATTENTION AND UNDERSTANDING. THE SAFETY WARNINGS DO NOT BY THEMSELVES ELIMINATE ANY DANGER. THE INSTRUCTIONS OR WARNINGS THEY GIVE ARE NOT SUBSTITUTES FOR PROPER ACCIDENT PREVENTION MEASURES.

SYMBOL	MEANING
	DANGER: Failure to obey a safety warning will result in serious injury to yourself or to others. Always follow the safety precautions to reduce the risk of fire, electric shock, and personal injury.
	WARNING: Failure to obey a safety warning can result in injury to yourself and others.
	CAUTION: Failure to obey a safety warning may result in property damage or personal injury to yourself or to others. Always follow the safety precautions to reduce the risk of fire, electric shock, and personal injury.
NOTE:	Advises you of information or instructions vital to the operation or maintenance of the equipment.

IMPORTANT SAFETY INFORMATION



WARNING: Always follow the safety precautions to reduce the risk of fire, electric shock and personal injury. Make sure this manual is carefully read and understood before starting or operating this equipment.

Service Information

Service on this unit both within and after the warranty period should be performed only by an authorized and approved service dealer. Dial **1-800-345-8746** in the United States or **1-800-265-6778** in Canada to obtain the listing of the authorized service dealer nearest you. Do not return the unit to the retailer.

FOR QUESTIONS, CALL 1-800-345-8746 IN U.S., OR 1-800-265-6778 in CANADA

RULES FOR SAFE OPERATION

BEFORE OPERATING

- Carefully read and understand the operator's manual of the unit that powers this attachment.
- Inspect the area before starting the unit. Remove all debris, and hard and sharp objects.
- Do not allow to be used as a toy.

WHILE OPERATING

- Always wear safety goggles/glasses at all times when using the blower. They provide protection against flying objects and dust.
- Do not operate the unit while under the influence of drugs, alcohol or medication.
- Do not point the unit in anyone's direction or in the direction of windows. Failure to obey this warning will result in serious personal injury.
- Wear a dust mask if use will create a dust laden environment.
- Dress properly. Do not operate this blower when barefoot or wearing open sandals. Always wear sturdy, rubber-soled footwear. The use of gloves, ear/hearing protection and long pants are recommended.
- Do not wear loose-fitting clothing or articles such as scarves, strings, chains, ties, etc., because they could get drawn into the air intake. Also make sure long hair does not get drawn into the air intake.
- Keep the air intake opening clear of debris.
- Keep clothing and body parts away from all moving parts and the engine exhaust outlet.
- Use only as described in this manual. Use only manufacturer's recommended attachments.
- Use extra care when cleaning on steps or stairs.
- Operate this blower in a well-ventilated area outdoors. Carbon monoxide exhaust fumes can be lethal in a confined area.
- Do not blow in anyone's direction. The blower can propel small objects at high speed.
- After striking a foreign object, stop the motor/engine and inspect the blower for damage. Repair any damage before further operation is attempted. Do not operate the blower with loose or damaged parts.
- Keep bystanders, especially children, and pets at least 30 ft (9.1 m) away.
- Look behind and use care when backing up.

- Never operate without good visibility or light.
- Exercise caution to avoid slipping or falling.

AFTER OPERATING

- Only qualified personnel should perform any repairs or maintenance procedures that are not described in this manual.

SPECIAL SAFETY WARNINGS FOR ELECTRIC POWERHEADS AND BLOWER

- Do not use in rain.
- Avoid dangerous environments - never operate blower in damp or wet conditions.
- Do not handle plug or appliance with wet hands.
- To reduce the risk of electric shock, do not expose the unit to rain or operate unit on wet ground.
- Always unplug the unit and allow it to cool before putting it into storage. Store indoors.
- Always unplug the unit when not in use, and before performing any maintenance or repairs.





SPECIAL SAFETY WARNINGS FOR GAS POWERHEADS AND BLOWER

- Avoid spilling the fuel when mixing the oil.
- Do not smoke while fueling the power unit.
- Fuel the power unit in a well-ventilated area.
- Move away from the fueling area when starting the unit.
- Do not smoke while operating the unit.
- Do not wear rubber or other insulated gloves when operating the unit to avoid static electricity shock.
- Store in an area free of potential fuel vapor ignition sources such as open flames (pilot lights) or electrical sparking devices (switches, electric motors).
- Turn off the engine and let it cool before refueling or before putting the unit in storage.

RULES FOR SAFE OPERATION

SAFETY AND INTERNATIONAL SYMBOLS

This operator's manual describes safety and international symbols and pictographs that may appear on this product. Read the operator's manual for complete safety, assembly, operating and maintenance and repair information.

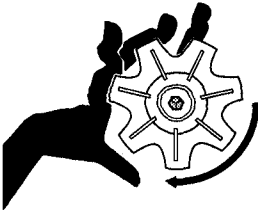
SYMBOL	MEANING
	<ul style="list-style-type: none">• SAFETY ALERT SYMBOL Indicates caution, warning or danger. May be used in conjunction with other symbols or pictographs.
	<ul style="list-style-type: none">• READ OPERATOR'S MANUAL Failure to follow operating instructions and safety precautions in operator's manual can result in serious injury. Read operator's manual before starting or operating this unit.
	<ul style="list-style-type: none">• WEAR EYE AND HEARING PROTECTION Warning. Thrown objects and loud noise can cause severe eye injury and hearing loss. Wear eye and ear protection when operating this unit.
	<ul style="list-style-type: none">• FOR SERVICE INFORMATION, CALL USA: 1-800-345-8746 CANADA: 1-800-265-6778
	<ul style="list-style-type: none">• BLOWERS ROTATING BLADES CAN CAUSE SEVERE INJURY. Place switch in "OFF" position and disconnect from power source before installing or changing nozzles. Do not put hands or any other object into fan housing.

OPERATING INSTRUCTIONS

OPERATING CLICK-LINK® SYSTEM

Your powerhead is equipped with a Click-Link® System, which enables optional attachments to be installed on the powerhead unit.

The optional attachments are:

Sweeper/Blower	SB720r
Vacuum	LV720r
Edger	LE720r
Cultivator	GC720r
Straight Shaft Trimmer	SS720r or SS725r
Tree Pruner	TP720r
Snow Thrower	ST720r
Hedge Trimmer	HS720r or HD720r
Blower/Vacuum	BV720r

Removing the Lower (Attachment) Boom

NOTE: To make removing the boom easier, place the unit on the ground or on a table.

1. Loosen the knob **counterclockwise** (Fig. 1).
2. Push the release button **in** (Fig. 1).
3. Pull the lower boom straight out of the Click-Link (Fig. 2).

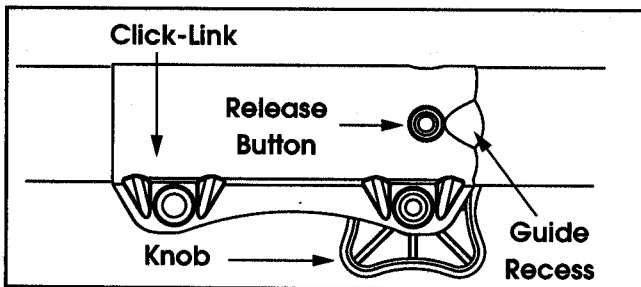

Fig. 1

If your unit is not assembled or you have more than one attachment, use the following instructions:

Installing the Lower (Attachment) Boom

1. Remove the hanger from the lower (attachment) boom. Hold the release button down while pushing the lower (attachment) boom into the Click-Link (Fig. 2).
2. Tighten the knob **clockwise** before using the unit.



CAUTION: Make sure the release button is **locked** in the primary hole before operating this unit.



CAUTION: All attachments are designed to be used in the primary hole unless otherwise indicated in the specific attachment's operator's manual. If the incorrect hole is used, you could damage your unit.

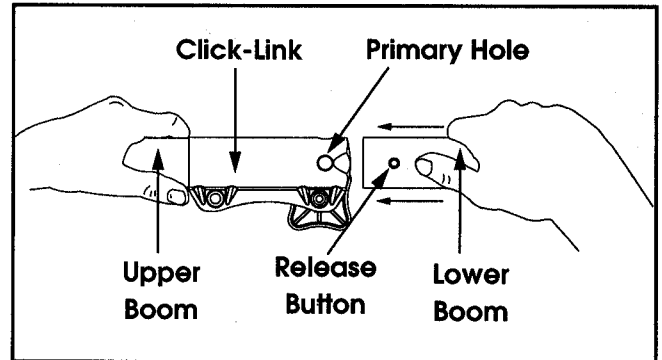

Fig. 2

OPERATING INSTRUCTIONS

INTERCHANGING NOZZLES

Your unit is completely assembled and installed with a flare nozzle (Fig. 3). The concentrator nozzle is in the box (Fig. 4). Use the following instructions to interchange the two nozzles.



WARNING: To avoid serious personal injury, do not insert hands into nozzles when removing or installing them.



WARNING: To reduce risk of injury, disconnect power source before removing nozzles.

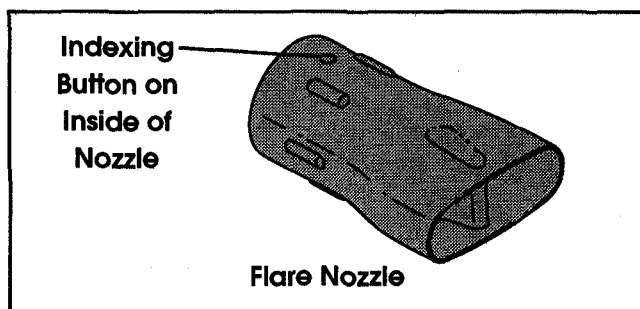

Fig. 3

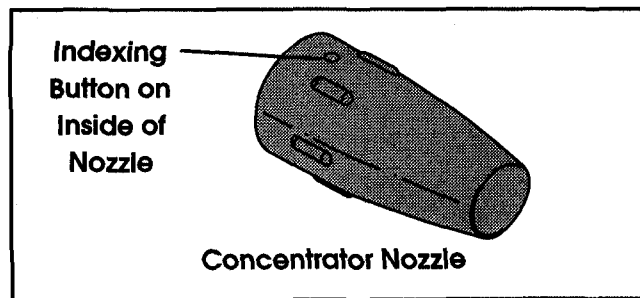

Fig. 4

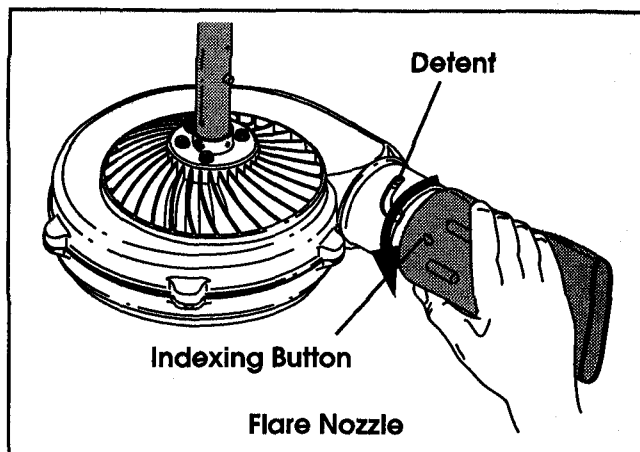

Fig. 5a

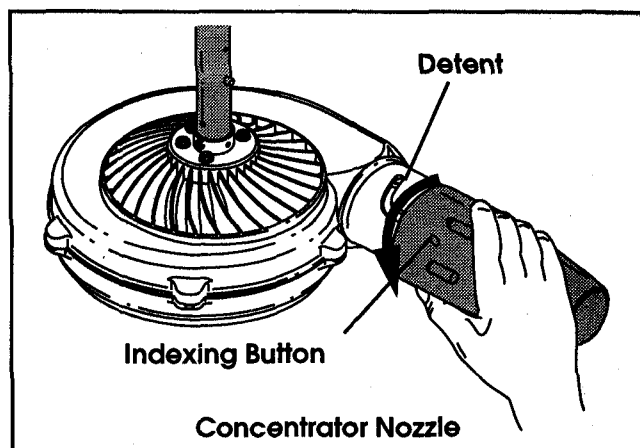

Fig. 5b

Removing Flare or Concentrator Nozzle from Blower Housing

1. Grasp the nozzle and turn it **counterclockwise** approximately 45° until the indexing button on the inside of the nozzle snaps out of the detent in the blower housing (Fig. 5a for the flare nozzle and Fig. 5b for the concentrator nozzle). Pull the nozzle off of the blower housing.

OPERATING INSTRUCTIONS

Installing Flare or Concentrator Nozzle onto Blower Housing

1. Align the indexing button on the inside of the nozzle with the detent on the housing (Fig. 6a for the concentrator nozzle, and Fig. 6b for the flare nozzle).
2. Push the nozzle onto the housing and turn the nozzle **clockwise** until it locks (Fig. 7a for the concentrator nozzle, and Fig. 7b for the flare nozzle).

NOTE: Make sure the nozzles are installed properly, with indexing button facing up, before operating the unit.

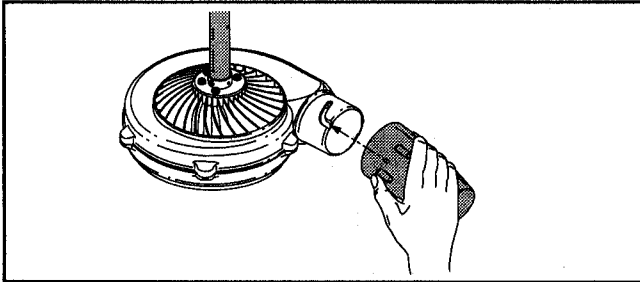

Fig. 6a

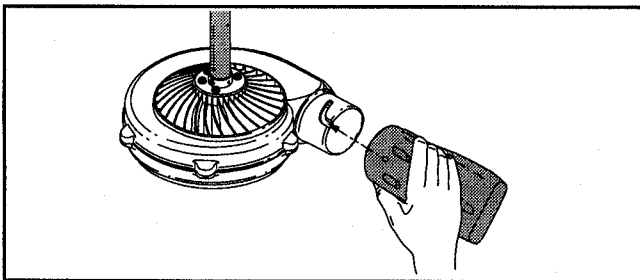

Fig. 6b

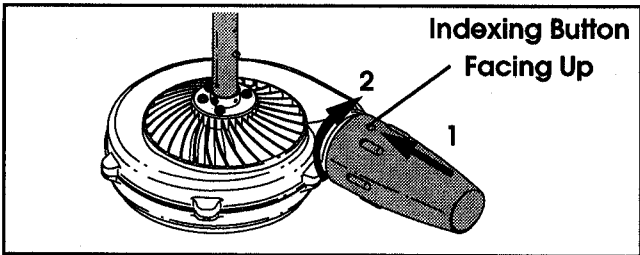

Fig. 7a

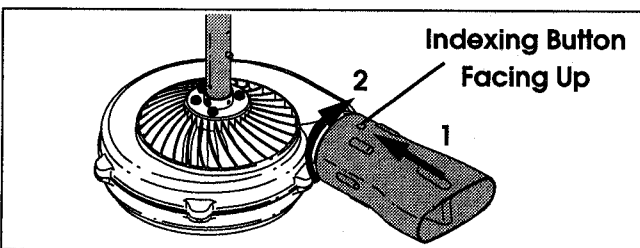

Fig. 7b

Using the Flare Nozzle

Use the flare nozzle for large, hard surface areas such as driveways and sidewalks (Fig. 8).

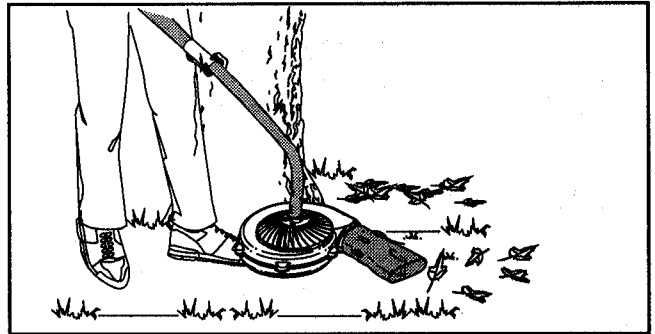

Fig. 8

Using the Concentrator Nozzle

Use the concentrator nozzle for hard to reach places such as corners in a garage or to control dust in a dust laden environment (Fig. 9).

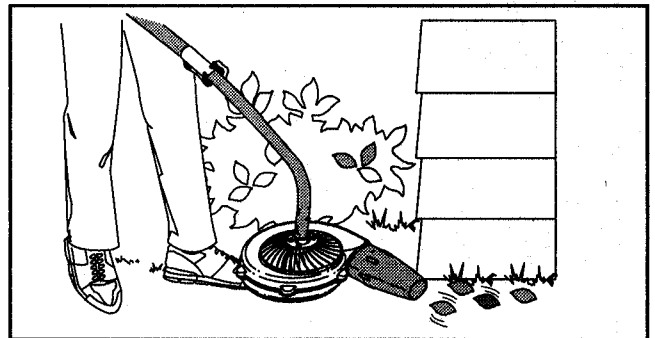

Fig. 9

Storing the Attachment

Your unit is equipped with an accessory hanger to allow you to hang the blower attachment from a wall (Fig. 10).

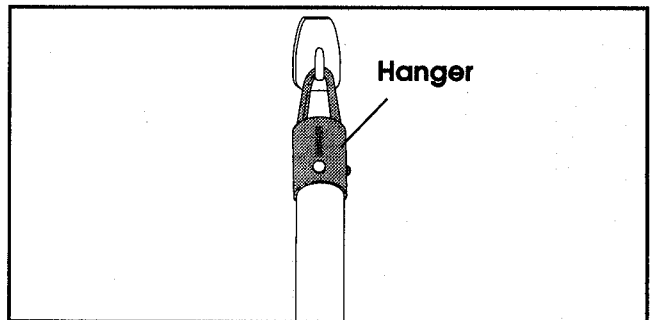

Fig. 10

SPECIFICATIONS

Operating Weight of Attachment: 3.25 lbs (1.46 kg)

BLOWER PARTS - MODEL TB720r

(Serial no. 61100001 and greater)

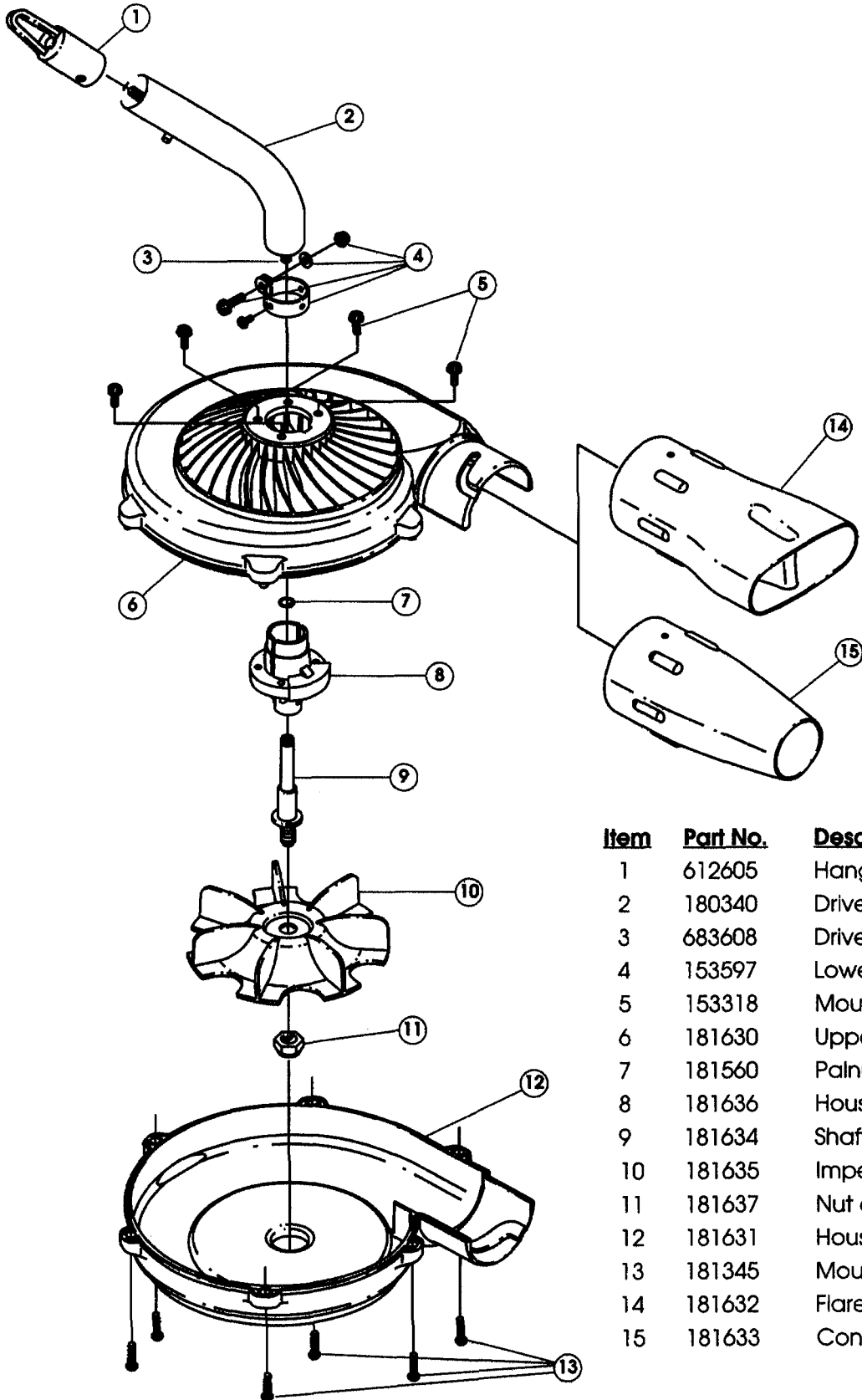

Item	Part No.	Description
1	612605	Hanger
2	180340	Drive Shaft Housing Assembly
3	683608	Drive Shaft Assembly
4	153597	Lower Clamp Assembly
5	153318	Mounting Screw
6	181630	Upper Housing
7	181560	Painut
8	181636	Housing, Bushing Assembly
9	181634	Shaft Impeller
10	181635	Impeller
11	181637	Nut and Washer
12	181631	Housing, Lower
13	181345	Mounting Screw
14	181632	Flare Nozzle
15	181633	Concentrator Nozzle

FOR QUESTIONS, CALL 1-800-345-8746 IN U.S. OR 1-800-265-6778 in CANADA

Limited Two-Year Warranty

RYOBI OUTDOOR PRODUCTS warrants each new RYOBI Product for two (2) years according to the following terms.

This warranty extends to the original retail purchaser only and commences on the date of original retail purchase.

Any part of the RYOBI Product manufactured or supplied by RYOBI and found in the reasonable judgement of RYOBI to be defective in material or workmanship will be repaired or replaced by an authorized RYOBI service dealer without charge for parts and labor.

The RYOBI Product including any defective part must be returned to an authorized service dealer within the warranty period. The expense of delivering the RYOBI Product to the dealer for warranty work and the expense of returning it back to the owner after repair or replacement will be paid for by the owner. RYOBI's responsibility in respect to claims is limited to making the required repairs or replacements and no claim of breach of warranty shall be cause for cancellation or rescission of the contract of sale of any RYOBI Product. Proof of purchase will be required by the dealer to substantiate any warranty claim. All warranty work must be performed by an authorized RYOBI service dealer.

This warranty is limited to ninety (90) days from the date of original retail purchase for any RYOBI Product that is used for rental or commercial purposes, or any other income-producing purpose.

This warranty does not cover any RYOBI Product that has been subject to misuse, neglect, negligence, or accident, or that has been operated in any way contrary to the operating instructions as specified in the RYOBI Operator's Manual. This warranty does not apply to any damage to the RYOBI Product that is the result of improper maintenance or to any RYOBI Product that has been altered or modified so as to adversely affect the products operation, performance or durability or that has been altered or modified so as to change its intended use. The warranty does not extend to repairs made necessary by normal wear or by the use of parts or accessories which are either incompatible with the RYOBI Product or adversely affect its operation, performance or durability.

In addition, this warranty does not cover:

- A. Tune-ups - Spark Plugs, Carburetor Adjustments, Filters
- B. Wear Items - Bump Knobs, Outer Spools, Cutting Line, Inner Reels, Starter Pulley, Starter Ropes, Drive Belts

RYOBI reserves the right to change or improve the design of any RYOBI Product without assuming any obligation to modify any product previously manufactured.

ALL IMPLIED WARRANTIES ARE LIMITED IN DURATION TO THE TWO (2) YEAR WARRANTY PERIOD OR NINETY (90) DAYS FOR PRODUCTS USED FOR ANY COMMERCIAL PURPOSE. ACCORDINGLY, ANY SUCH IMPLIED WARRANTIES INCLUDING MERCHANTABILITY, FITNESS FOR A PARTICULAR PURPOSE, OR OTHERWISE, ARE DISCLAIMED IN THEIR ENTIRETY AFTER THE EXPIRATION OF THE APPROPRIATE TWO-YEAR OR NINETY DAY WARRANTY PERIOD. RYOBI'S OBLIGATION UNDER THIS WARRANTY, IS STRICTLY AND EXCLUSIVELY LIMITED TO THE REPAIR OR REPLACEMENT OF DEFECTIVE PARTS, AND ROP DOES NOT ASSUME OR AUTHORIZE ANYONE TO ASSUME FOR THEM ANY OTHER OBLIGATION. SOME STATES DO NOT ALLOW LIMITATIONS ON HOW LONG AN IMPLIED WARRANTY LASTS, SO THE ABOVE LIMITATION MAY NOT APPLY TO YOU.

RYOBI ASSUMES NO RESPONSIBILITY FOR INCIDENTAL, CONSEQUENTIAL OR OTHER DAMAGES INCLUDING, BUT NOT LIMITED TO EXPENSE OF RETURNING THE RYOBI PRODUCT TO AN AUTHORIZED SERVICE DEALER AND EXPENSE OF DELIVERING IT BACK TO THE OWNER, MECHANIC'S TRAVEL TIME, TELEPHONE OR TELEGRAM CHARGES, RENTAL OF A LIKE PRODUCT DURING THE TIME WARRANTY SERVICE IS BEING PERFORMED, TRAVEL, LOSS OR DAMAGE TO PERSONAL PROPERTY, LOSS OF REVENUE, LOSS OF USE OF THE PRODUCT, LOSS OF TIME, OR INCONVENIENCE. SOME STATES DO NOT ALLOW THE EXCLUSION OR LIMITATION OF INCIDENTAL OR CONSEQUENTIAL DAMAGES, SO THE ABOVE LIMITATION OR EXCLUSION MAY NOT APPLY TO YOU.

This warranty gives you specific legal rights, and you may also have other rights which vary from state to state.

This warranty applies to all RYOBI Products manufactured by RYOBI and sold in the United States and Canada.

To locate your nearest service dealer dial 1-800-345-8746 in the United States or 1-800-265-6778 in Canada.

RYOBI®

RYOBI OUTDOOR PRODUCTS

550 N. 54th Street
Chandler, AZ 85226 U.S.A.

RYOBI CANADA INC.

275 Industrial Rd
Cambridge, Ontario N1R 6K2 CANADA

FOR QUESTIONS, CALL 1-800-345-8746 IN U.S. OR 1-800-265-6778 in CANADA

**OPERATOR'S MANUAL PART NO. 181638
PRINTED IN USA**

**MANUEL DE FONCTIONNEMENT RÉF. 181364
IMPRIMÉ AUX É.U.**

**MANUAL DEL OPERADOR, No. de serie 181638
IMPRESO EN LOS EE.UU**

**REV. A (6847)
11/96**

**RÉV. A (6847)
11/96**

**REV. A (6847)
11/96**